

PRODUCT SPECIFICATION

产品规格书

PRODUCT: Metal Oxide Varistor (MOV)
 氧化锌压敏电阻器

TYPE: V Series

PART NO: _____

CUSTOMER: _____

DOC. NO.: HW-V01-03

APPROVED BY CUSTOMER

MANUFACTURER 制造商：

Guangdong Huiwan Electronics Technology Co.,LTD.

广东汇万电子科技有限公司

Plant C, the Dichong second industrial park, Gaobu town,

Dongguan city, Guangdong province, China.

广东省东莞市高埗镇低涌第二工业区厂房 C

Postcode: 523287

Tel 电话: 0769-81338786 Fax 传真: 0769-81338796

<http://www.gd-hwe.com>



Record of change 更改记录

Date 日期	Version 版次	Description 更改内容描述	Page 页次
2015/11/12	1	1 st edition 初版	
2017/11/21	2	Add lead type code S 增加 S 脚型(直弯脚型)	4、7、12
2018/11/1	3	Add taping code AF and AT 增加编带码 AF、AT	4、14、15、16

1. Part Numbering 产品编码:

(1)	(2~4)	(5)	(6~7)	(8)	(9)	(10~11)	(12)	(13)	(14~17)
V	471	K	10	D	L	20	A	7	0000

(1) Type code 型号代码:

V: Varistor

(2~4) Varistor voltage(DC) 压敏电压(直流):

Identified by 3-figure code 三位数表 Ex 示例: 820=82V, 101=100V, 102=1000V

(5) Tolerance of varistor voltage 压敏电压允差: K=±10%
(6~7) Disc size series 本体尺寸系列: 07=7mm,10=10mm,14=14mm,20=20mm
(8) Energy type 能量类别: D=Standard energy type 标准能量品; E=High energy 高能量品
(9) Lead type 引线类型:

Code 代码	Description 描述	Code 代码	Description 描述
L	Straight lead 直脚	X	Outside kink lead 外弯脚
D	Vertical kink lead 垂直弯脚	H	Inside kink lead 内弯脚
S	Straight kink lead 直弯脚		

(10~11) Lead length or taping type 脚长或编带类型(≥511K 产品较厚, 不适用于编带包装):

Taping code 编带	Description 描述	Bulk code 散装	Description 描述
AG	Ammo box / Pitch-P:12.7mm / Pitch of hole-P0:12.7 mm / Lead space5.0mm or 7.5mm	03	Lead length: 3.0mm
		3E	Lead length: 3.5mm
AU	Ammo box / Pitch-P:25.4mm / Pitch of hole-P0:12.7 mm / Lead space7.5mm	04	Lead length: 4.0mm
		4E	Lead length: 4.5mm
AW	Ammo box / Pitch-P:25.4mm / Pitch of hole-P0:12.7 mm / Lead space10.0mm	05	Lead length: 5.0mm
		07	Lead length: 7.0mm
AF	Ammo box / Pitch-P: 15.0mm / Pitch of hole-P0: 15.0mm / Lead space5.0mm or 7.5mm	10	Lead length: 10mm
		20	Lead length: 20mm
AT	Ammo box / Pitch-P: 30.0mm / Pitch of hole-P0: 15.0mm / lead space 7.5mm or 10mm		

(12) Lead length tolerance 脚长误差:

Code 代码	Description 描述	Code 代码	Description 描述
A	±0.5 mm (Only for kink lead type)	C	Minimum.
B	±1.0 mm	D	Taping special purpose

(13) Lead space 脚距:

Code 代码	Description 描述	Code 代码	Description 描述
5	5.0±0.5 mm	E	5.0±1 mm
7	7.5±0.5 mm	M	7.5±1 mm
0	10.0±0.5 mm	A	10.0±1 mm
C	12.5±0.5 mm	D	12.5±1 mm

(14~17) Special specification code 特殊规格码:

0000: Normal products, omit code. 表示标准品, 号码省略。Any other four codes: Special specification can't contain in above codes.其它四码表示特殊规格品。

2. Applications 应用:

- 2.1 Surge protection in 应用于以下产品之浪涌保护
- 2.2 Consumer electronics 消费性电子
- 2.3 Industrial electronics 工业电子
- 2.4 Communication electronics 通讯电子
- 2.5 Measuring and controlling systems 量测控制
- 2.6 Electronic home appliances 家用电器
- 2.7 Protection against surges induced by lightning striking incoming power lines.
电力线路的雷击防护
- 2.8 Suppression of surges caused by switching inductive loads such as transformers, relays and coils. 变压器、继电器、线圈等开关负载而产生的浪涌抑制防护
- 2.9 Protection of rectification diodes, SCRs, power transistors, semiconductor devices, etc
保护二极管、晶闸管、晶体管及半导体等器件

3. Features 特点:

- 3.1 High performance transient voltage suppression 具有极好的瞬态电压抑制性能
- 3.2 Short response time to surge voltage 浪涌电压响应时间短
- 3.3 Low standby power dissipation 备用功率损失小
- 3.4 Excellent clamping characteristics 抑制特性好.
- 3.5 High performance withstanding surge currents 具有极好的抗冲击电流性能
- 3.6 Coated with flame-retardant epoxy resin (conforming to UL94V-0 standard).涂有阻燃环氧树脂层(符合 UL94V-0 标准)
- 3.7 Comply with EU RoHS, and Halogen-free products 符合欧盟 RoHS 指令, 无卤产品.
- 3.8 High reliability 高信赖性
- 3.9 Taping available for automatic insertion.可提供适合于自动插件需求的编带品.
- 3.10 UL, cUL, VDE and CQC recognized UL/cUL/VDE/CQC 安全认证

Safety institute 安规机构	Certified No. 认证号码	Safety institute 安规机构	Certified No. 认证号码
UL	E480104 (VZCA2)	VDE	40043880
CUL	E480104 (VZCA8)	CQC	CQC16001143876/ CQC16001143878 CQC16001150660/CQC16001150661

4. Definition of Varistor Terms 压敏电阻相关定义:

- 4.1 Rated RMS Voltage 电压有效值, Rated DC Voltage 额定直流电压: The maximum designated values of power system voltage that may be applied continuously between the terminals of a device.
- 4.2 Varistor Voltage 压敏电压: Test characteristic that is used to classify varistors by type. A test current of 1mA DC is typically used to determine varistor voltage classification type. Varistor voltage clamping characteristics can be defined at various test levels.
- 4.3 Rated Peak Single Pulse Transient Current 单次脉冲瞬态电流最大值: Maximum surge current, 8/20 μ s waveform which a varistor is rated to withstand for a single surge.
- 4.4 Rated Single Pulse Transient Energy 单次脉冲瞬态能量: Maximum allowable energy for a single impulse (see specified waveforms).
- 4.5 Maximum Clamping Voltage 最大抑制电压: Measured peak voltage across the device terminals when a current impulse of specified amplitude and waveform is conducted through the varistor.
- 4.6 Typical Capacitance 电容量参考值: Typical capacitance values are measured at a test frequency of 1kHz. Capacitance values are only for reference purpose only, not subject to outgoing inspection.

5. General Characteristics 一般特性

5.1 Storage Temperature 储存温度：-55℃ to +125℃

5.2 Operating Ambient Temperature 工作环境温度(without derating)：

UL(cUL): -40℃ to +85℃； CQC: -40℃ to +125℃； VDE: -55℃ to +125℃；

5.3 Maximum Voltage-Temperature Coefficient 电压-温度特性最大值：$-0.05\%/^{\circ}\text{C}$

5.4 Insulation Resistance 绝缘电阻：1000Mega-ohm minimum

5.5 Hi Pot (Leads to Case)包封层耐压：2500VDC for 1 min.

5.6 Typical Response Time 响应时间：<math>< 15</math> Nano-seconds

5.7 Current/Energy Derating 电流/能量降额 (>85℃)：-2.5 % /℃

5.8 DC Leakage Current DC 漏电流：200μA maximum (at rated DC working voltage)

5.9 Power Dissipation Ratings 额定功率损耗(P, in-watts)：

Disc Size	P(W)
7mm	0.25
10mm	0.4
14mm	0.6
20mm	1.0

● Energy Derating Versus Temperature

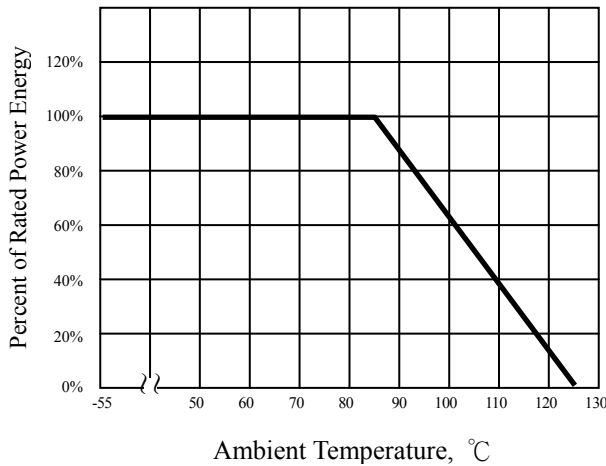

● Peak Current Per Pulse Versus Pulse Duration

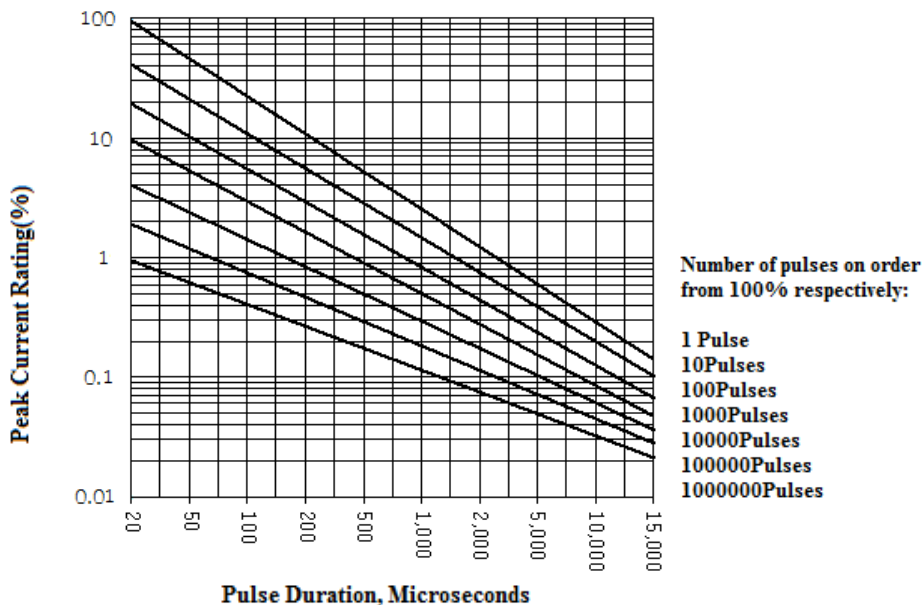

6. Dimensions quick reference 尺寸快速参考:

Disc size Series	07	10	14	20
Dmax	10.0	14.0	17.5	24.0
d	0.55±0.05	0.8±0.05	0.8±0.05	1.0±0.1
W	5.0	7.5	7.5	10.0
Hmax	15.5	20.0	23.5	31.5
H1max	13.5	17.0	20.5	28.5
Tmax	Refer to the part list pages 请参考料号列表页			

(Unit: mm)

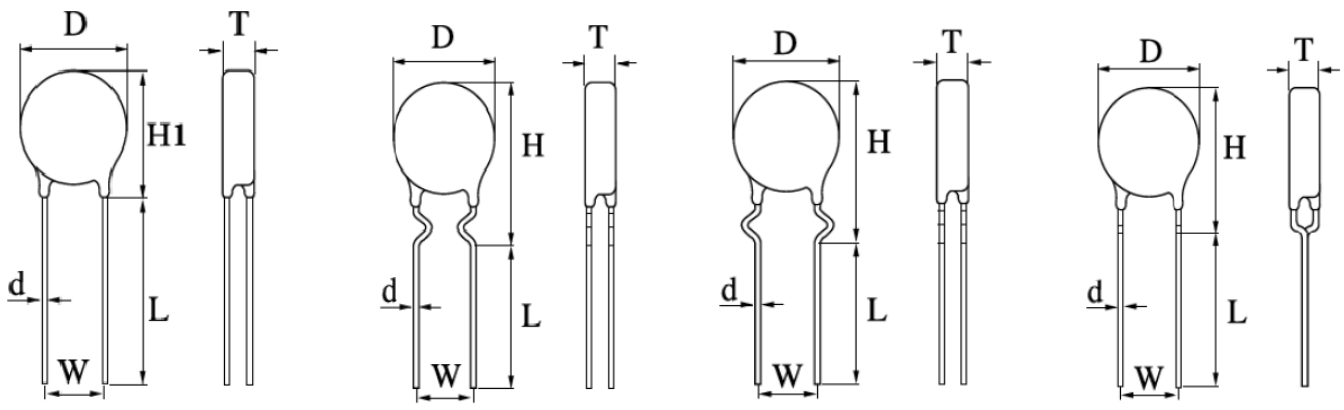
 L : Straight lead
 直脚型

 H : Inside kink lead
 内弯脚型

 X : Outside kink lead
 外弯脚型

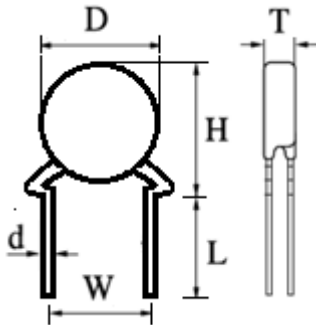
 D : Vertical kink lead
 前后弯脚型

 S : Straight kink lead
 直弯脚型

7. Varistors - Series part list 压敏电阻系列料号列表:
7.1 07 Series 07 系列:

Part Number 料号	Max. Allowable Voltage 最大允许电压		Varistor Voltage 压敏电压		Withstanding Surge Current 耐冲击电流 (8/20 μ s)			Max. Energy 最大能量			Withstanding Surge Current 耐冲击电流 (8/20 μ s)		Max. Energy 最大能量		Max. Clamping Voltage 最大抑制电压 (8/20 μ s)		Typical Capacitance 参考容量	Thickness of product 产品厚度 Max
	AC rms	DC	DC Volts		High Energy 高能			Standard 普通			Vc	Ip	@1kHz	mm				
					1 time	2 times	10/1000 μ s	1 time	2 times	10/1000 μ s								
	V	V	Min	Max	Amps	Amps	Joules	Amps	Amps	Joules	Volts	Amps	pF					
V 820K07□□	50	65	73.8	90.2	1750	1200	10	1200	600	5.5	135	10	750	4.9				
V 101K07□□	60	85	90	110	1750	1200	12	1200	600	6.5	165	10	630	5.1				
V 121K07□□	75	100	108	132	1750	1200	13	1200	600	7.8	200	10	520	5.3				
V 151K07□□	95	125	135	165	1750	1200	15	1200	600	9.7	250	10	450	5.6				
V 181K07□□	115	150	162	198	1750	1200	16	1200	600	11.7	300	10	400	5.8				
V 201K07□□	130	170	180	220	1750	1200	17	1200	600	13	340	10	250	5.0				
V 221K07□□	140	180	198	242	1750	1200	19	1200	600	14	360	10	240	5.1				
V 241K07□□	150	200	216	264	1750	1200	21	1200	600	15	395	10	220	5.2				
V 271K07□□	175	225	243	297	1750	1200	24	1200	600	18	455	10	195	5.3				
V 301K07□□	195	250	270	330	1750	1200	26	1200	600	20	500	10	175	5.5				
V 331K07□□	210	275	297	363	1750	1200	29	1200	600	23	550	10	160	5.6				
V 361K07□□	230	300	324	396	1750	1200	32	1200	600	24	595	10	150	5.7				
V 391K07□□	250	320	351	429	1750	1200	35	1200	600	26	650	10	140	5.8				
V 431K07□□	275	350	387	473	1750	1200	40	1200	600	28	710	10	120	6.0				
V 471K07□□	300	385	423	517	1750	1200	42	1200	600	29	775	10	110	6.2				
V 511K07□□	320	415	459	561	1750	1200	45	1200	600	31	840	10	105	6.3				
V 531K07□□	330	435	477	583	1750	1200	47	1200	600	33	875	10	100	6.4				
V 561K07□□	350	460	504	616	1750	1200	49	1200	600	35	915	10	95	6.5				
V 621K07□□	385	505	558	682	1750	1200	55	1200	600	38	1020	10	85	6.8				
V 681K07□□	420	560	612	748	1750	1200	60	1200	600	42	1120	10	77	7.0				
V 751K07□□	460	615	675	825	1750	1200	64	1200	600	45	1235	10	72	7.3				
V 781K07□□	485	640	702	858	1750	1200	69	1200	600	48	1280	10	68	7.5				
V 821K07□□	510	670	738	902	1750	1200	73	1200	600	52	1355	10	62	7.6				
V 911K07□□	550	745	819	1001	1750	1200	77	1200	600	57	1500	10	58	8.0				

● Safety approval 安规认证: UL/cUL/VDE/CQC

7.2 10 Series 10 系列:

Part Number 料号	Max. Allowable Voltage 最大允许电压		Varistor Voltage 压敏电压		Withstanding Surge Current 耐冲击电流 (8/20 μ s)			Max. Energy 最大能量			Withstanding Surge Current 耐冲击电流 (8/20 μ s)			Max. Energy 最大能量		Max. Clamping Voltage 最大抑制电压 (8/20 μ s)		Typical Capacitance 参考容量	Thickness of product 产品厚度 Max
	AC rms	DC	DC Volts		High Energy 高能			Standard 普通			Vc	Ip	@1kHz						
					1 time	2 times	10/1000 μ s	1 time	2 times	10/1000 μ s									
	V	V	Min	Max	Amps	Amps	Joules	Amps	Amps	Joules	Volts	Amps	pF	mm					
V 820K10□□	50	65	73.8	90.2	3500	2500	17	2500	1250	12	135	25	1200	4.9					
V 101K10□□	60	85	90	110	3500	2500	18	2500	1250	15	165	25	1100	5.1					
V 121K10□□	75	100	108	132	3500	2500	21	2500	1250	18	200	25	900	5.3					
V 151K10□□	95	125	135	165	3500	2500	25	2500	1250	22	250	25	800	5.6					
V 181K10□□	115	150	162	198	3500	2500	30	2500	1250	27	300	25	760	5.8					
V 201K10□□	130	170	180	220	3500	2500	35	2500	1250	30	340	25	500	5.0					
V 221K10□□	140	180	198	242	3500	2500	39	2500	1250	32	360	25	450	5.1					
V 241K10□□	150	200	216	264	3500	2500	42	2500	1250	35	395	25	430	5.2					
V 271K10□□	175	225	243	297	3500	2500	49	2500	1250	37	455	25	380	5.3					
V 301K10□□	195	250	270	330	3500	2500	54	2500	1250	40	500	25	340	5.5					
V 331K10□□	210	275	297	363	3500	2500	58	2500	1250	43	550	25	310	5.6					
V 361K10□□	230	300	324	396	3500	2500	65	2500	1250	47	595	25	290	5.7					
V 391K10□□	250	320	351	429	3500	2500	70	2500	1250	60	650	25	275	5.8					
V 431K10□□	275	350	387	473	3500	2500	80	2500	1250	65	710	25	250	6.0					
V 471K10□□	300	385	423	517	3500	2500	85	2500	1250	67	775	25	230	6.2					
V 511K10□□	320	415	459	561	3500	2500	90	2500	1250	68	845	25	210	6.3					
V 531K10□□	330	435	477	583	3500	2500	92	2500	1250	70	875	25	200	6.4					
V 561K10□□	350	455	504	616	3500	2500	94	2500	1250	72	925	25	190	6.5					
V 621K10□□	385	505	558	682	3500	2500	97	2500	1250	75	1025	25	170	6.8					
V 681K10□□	420	560	612	748	3500	2500	100	2500	1250	77	1120	25	160	7.0					
V 751K10□□	460	615	675	825	3500	2500	105	2500	1250	80	1240	25	140	7.3					
V 781K10□□	485	640	702	858	3500	2500	105	2500	1250	82	1290	25	135	7.5					
V 821K10□□	510	670	738	902	3500	2500	110	2500	1250	85	1355	25	130	7.6					
V 911K10□□	550	745	819	1001	3500	2500	130	2500	1250	100	1500	25	120	8.0					
V 102K10□□	625	825	900	1100	3500	2500	140	2500	1250	110	1650	25	100	8.4					
V 112K10□□	680	895	990	1210	3500	2500	155	2500	1250	120	1815	25	90	8.8					
V 182K10□□	1100	1465	1620	1980	3500	2500	247	2500	1250	170	2970	25	80	11.7					

● Safety approval 安规认证:

- UL/ VDE/CQC for all above items;
- cUL for all above items except V182K10□□

7.3 14 Series 14 系列:

Part Number 料号	Max. Allowable Voltage 最大允许电压		Varistor Voltage 压敏电压		Withstanding Surge Current 耐冲击电流 (8/20 μ s)			Max. Energy 最大能量			Withstanding Surge Current 耐冲击电流 (8/20 μ s)			Max. Energy 最大能量		Max. Clamping Voltage 最大抑制电压 (8/20 μ s)		Typical Capacitance 参考容量	Thickness of product 产品厚度 Max
	AC rms	DC	DC Volts		High Energy 高能			Standard 普通			Vc	Ip	@1kHz	z	mm				
					1 time	2 times	10/1000 μ s	1 time	2 times	10/1000 μ s									
	V	V	Min	Max	Amps	Amps	Joules	Amps	Amps	Joules	Volts	Amps	pF	mm					
V 820K14□□	50	65	73.8	90.2	6000	4500	27	4500	2500	22	135	50	2400	4.9					
V 101K14□□	60	85	90	110	6000	4500	33	4500	2500	28	165	50	2000	5.1					
V 121K14□□	75	100	108	132	6000	4500	40	4500	2500	32	200	50	1700	5.3					
V 151K14□□	95	125	135	165	6000	4500	53	4500	2500	40	250	50	1500	5.6					
V 181K14□□	115	150	162	198	6000	4500	60	4500	2500	50	300	50	1300	5.8					
V 201K14□□	130	170	180	220	6000	4500	70	4500	2500	57	340	50	1000	5.0					
V 221K14□□	140	180	198	242	6000	4500	78	4500	2500	60	360	50	900	5.1					
V 241K14□□	150	200	216	264	6000	4500	84	4500	2500	63	395	50	800	5.2					
V 271K14□□	175	225	243	297	6000	4500	99	4500	2500	70	455	50	700	5.3					
V 301K14□□	195	250	270	330	6000	4500	108	4500	2500	77	500	50	650	5.5					
V 331K14□□	210	275	297	363	6000	4500	115	4500	2500	85	550	50	610	5.6					
V 361K14□□	230	300	324	396	6000	4500	130	4500	2500	93	595	50	580	5.7					
V 391K14□□	250	320	351	429	6000	4500	140	4500	2500	100	650	50	530	5.8					
V 431K14□□	275	350	387	473	6000	4500	155	4500	2500	115	710	50	500	6.0					
V 471K14□□	300	385	423	517	6000	4500	175	4500	2500	118	775	50	470	6.2					
V 511K14□□	320	415	459	561	6000	4500	180	4500	2500	122	845	50	420	6.3					
V 531K14□□	330	435	477	583	6000	4500	185	4500	2500	125	875	50	400	6.4					
V 561K14□□	350	455	504	616	6000	4500	192	4500	2500	128	925	50	380	6.5					
V 621K14□□	385	505	558	682	6000	4500	195	4500	2500	132	1025	50	340	6.8					
V 681K14□□	420	560	612	748	6000	4500	200	4500	2500	135	1120	50	320	7.0					
V 751K14□□	460	615	675	825	6000	4500	210	4500	2500	143	1240	50	290	7.3					
V 781K14□□	485	640	702	858	6000	4500	225	4500	2500	148	1290	50	270	7.5					
V 821K14□□	510	670	738	902	6000	4500	235	4500	2500	157	1355	50	260	7.6					
V 911K14□□	550	745	819	1001	5000	4500	255	4500	2500	175	1500	50	240	8.0					
V 102K14□□	625	825	900	1100	5000	4500	280	4500	2500	190	1650	50	220	8.4					
V 112K14□□	680	895	990	1210	5000	4500	310	4500	2500	213	1815	50	200	8.8					
V 182K14□□	1100	1465	1620	1980	5000	4500	510	4500	2500	250	2970	50	180	11.7					
V 222K14□□	1340	1780	1980	2420	5000	4500	620	4500	2500	305	3630	50	110	13.4					

- Safety approval 安规认证: UL/cUL/VDE/CQC
 - VDE/CQC for all above items;
 - UL/ cUL for all above items except V182K14□□ and V222K14□□

7.4 20 Series 20 系列:

Part Number 料号	Max. Allowable Voltage 最大允许电压		Varistor Voltage 压敏电压		Withstanding Surge Current 耐冲击电流 (8/20 μ s)			Max. Energy 最大能量			Withstanding Surge Current 耐冲击电流 (8/20 μ s)			Max. Energy 最大能量		Max. Clamping Voltage 最大抑制电压 (8/20 μ s)		Typical Capacitance 参考容量	Thickness of product 产品厚度 Max
	AC rms	DC	DC Volts		High Energy 高能			Standard 普通			Vc	Ip	@1kHz						
					1 time	2 times	10/1000 μ s	1 time	2 times	10/1000 μ s									
	V	V	Min	Max	Amps	Amps	Joules	Amps	Amps	Joules	Volts	Amps	pF	mm					
V 820K20□□	50	65	73.8	90.2	10000	6500	56	6500	4500	45	135	100	5500	4.9					
V 101K20□□	60	85	90	110	10000	6500	70	6500	4500	50	165	100	4800	5.1					
V 121K20□□	75	100	108	132	10000	6500	85	6500	4500	55	200	100	4000	5.3					
V 151K20□□	95	125	135	165	10000	6500	106	6500	4500	70	250	100	3400	5.6					
V 181K20□□	115	150	162	198	10000	6500	130	6500	4500	85	300	100	2600	5.8					
V 201K20□□	130	170	180	220	10000	6500	140	6500	4500	95	340	100	2000	5.0					
V 221K20□□	140	180	198	242	10000	6500	180	6500	4500	100	360	100	1800	5.1					
V 241K20□□	150	200	216	264	10000	6500	200	6500	4500	108	395	100	1700	5.2					
V 271K20□□	175	225	243	297	10000	6500	210	6500	4500	127	455	100	1600	5.3					
V 301K20□□	195	250	270	330	10000	6500	216	6500	4500	136	500	100	1500	5.5					
V 331K20□□	210	275	297	363	10000	6500	228	6500	4500	150	550	100	1400	5.6					
V 361K20□□	230	300	324	396	10000	6500	255	6500	4500	163	595	100	1250	5.7					
V 391K20□□	250	320	351	429	10000	6500	275	6500	4500	180	650	100	1100	5.8					
V 431K20□□	275	350	387	473	10000	6500	303	6500	4500	190	710	100	1000	6.0					
V 471K20□□	300	385	423	517	10000	6500	350	6500	4500	204	775	100	900	6.2					
V 511K20□□	320	415	459	561	10000	6500	360	6500	4500	210	845	100	820	6.3					
V 531K20□□	330	435	477	583	10000	6500	370	6500	4500	215	875	100	800	6.4					
V 561K20□□	350	455	504	616	10000	6500	385	6500	4500	220	925	100	780	6.5					
V 621K20□□	385	505	558	682	10000	6500	390	6500	4500	224	1025	100	710	6.8					
V 681K20□□	420	560	612	748	10000	6500	400	6500	4500	230	1120	100	650	7.0					
V 751K20□□	460	615	675	825	10000	6500	420	6500	4500	255	1240	100	600	7.3					
V 781K20□□	485	640	702	858	10000	6500	445	6500	4500	265	1290	100	530	7.5					
V 821K20□□	510	670	738	902	10000	6500	460	6500	4500	282	1355	100	510	7.6					
V 911K20□□	550	745	819	1001	8000	6500	510	6500	4500	310	1500	100	500	8.0					
V 102K20□□	625	825	900	1100	8000	6500	560	6500	4500	342	1650	100	400	8.4					
V 112K20□□	680	895	990	1210	8000	6500	620	6500	4500	383	1818	100	370	8.8					
V 182K20□□	1100	1465	1620	1980	8000	6500	990	6500	4500	625	2970	100	330	11.7					

- Safety approval 安规认证: UL/cUL/VDE/CQC
 - UL/ VDE/CQC for all above items;
 - cUL for all above items except V182K20□□

8. Taping format 编带型式:

8.1 Taping Specifications 编带规格 7φ、10φ:

Taping Code 编带代码 AG: AMMO, P 12.7mm/P0 12.7mm/lead space 5.0mm or 7.5mm

Taping Code 编带代码 AP: REEL, P 12.7mm/P0 12.7mm/lead space 5.0mm or 7.5mm

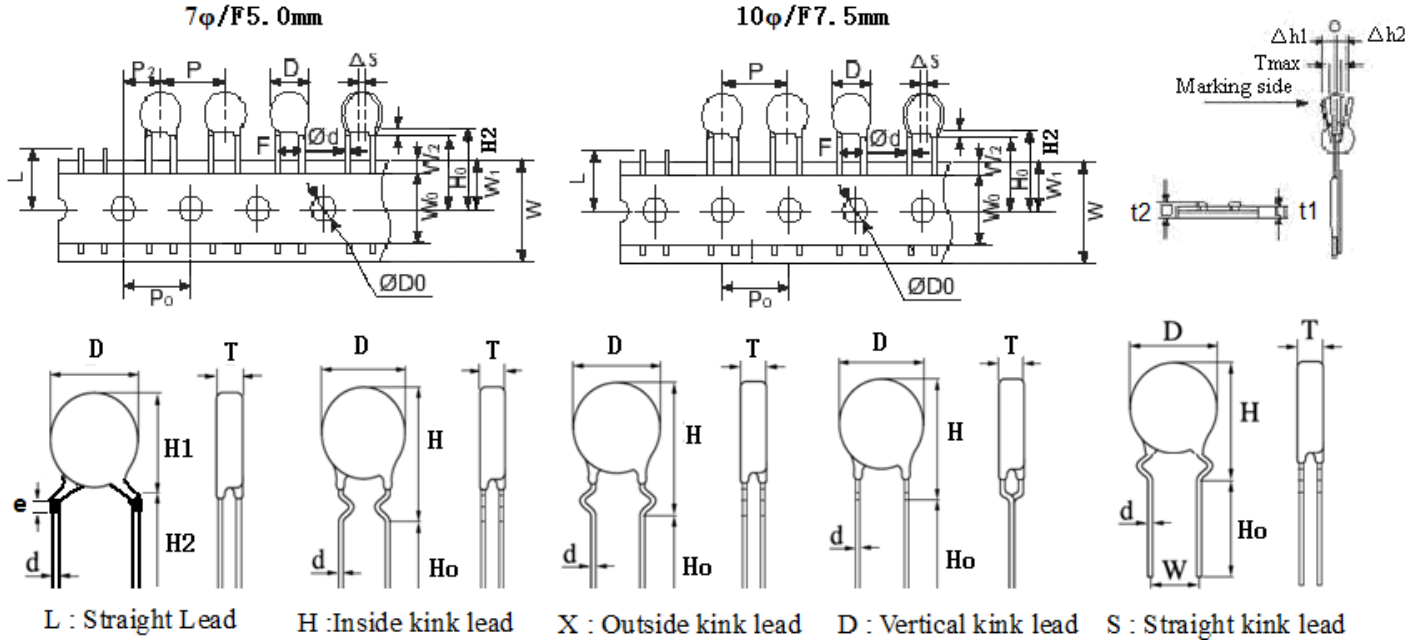

Item 项目		Taping code 编带代码: AG & AP					
		Disk Size: 7Φ			Disk Size: 10Φ		
Lead Type Code 线脚代码		L	X, H, S	D	L	X, H, S	D
Body Diameter 本体直径	D	10.0 Max	10.0 Max	10.0 Max	14.0 Max	14.0 Max	14.0 Max
Lead Wire Diameter 线脚直径	d	0.55±0.05	0.55±0.05	0.55±0.05	0.8±0.05	0.8±0.05	0.8±0.05
Pitch of Component 零件间距	P	12.7±1	12.7±1	12.7±1	12.7±1	12.7±1	12.7±1
Feed Hole Pitch 纸带孔中心距	P0	12.7±0.3	12.7±0.3	12.7±0.3	12.7±0.3	12.7±0.3	12.7±0.3
Hole Center to Component Center 孔中心与零件中心距离	P2	6.35±0.7	6.35±0.7	6.35±0.7	—	—	—
Lead to Lead Distance (Center to Center) 线脚中心距离	F	5.0±0.5	5.0±0.5	5.0±0.5	7.5±0.5	7.5±0.5	7.5±0.5
Component Alignment 零件前后偏移	Δh	2.0Max	2.0Max	2.0Max	2.0Max	2.0Max	2.0Max
Deviation along tape, left or right 本体偏移	ΔS	0±2.0	0±2.0	0±2.0	0±2.0	0±2.0	0±2.0
Base paper Tape Width 纸带宽度	W	18 +1.0/-0.5	18 +1.0/-0.5	18 +1.0/-0.5	18 +1.0/-0.5	18 +1.0/-0.5	18 +1.0/-0.5
Adhesive Tape Width 胶带宽度	W0	8.0Min	8.0Min	8.0Min	8.0Min	8.0Min	8.0Min
Hole Position 孔定位	W1	9±0.5	9±0.5	9±0.5	9±0.5	9±0.5	9±0.5
Adhesive Tape Border 胶带边缘距	W2	1.5Max	1.5Max	1.5Max	1.5Max	1.5Max	1.5Max
Lead-Wire Clinch Height 线脚高度	H0	—	16±0.5	16±0.5	—	16±1.0	16±1.0
Lead distance between the bottom of body and the center of sprocket hole 线脚高度(本体底至孔中心)	H2	18±2	—	—	18±2	—	—
Feed Hole Diameter 定位孔孔径	D0	4±0.2	4±0.2	4±0.2	4±0.2	4±0.2	4±0.2
Total Tape Thickness 纸带总厚度	t2	<1.5	<1.5	<1.5	<1.8	<1.8	<1.8
Length of Clipped Lead 裁切后线脚长度	L	11Max	11Max	11Max	11Max	11Max	11Max
Coating extension on leads 线脚上包封脚长	e	1.0Max	—	—	1.0Max	—	—
Component Height from Seating Plane 零件插板后高度	H	—	15.5Max	15.5Max	—	20Max	20Max
	H1	13.5Max	—	—	17.0Max	—	—

All dimensions are in millimeters. 尺寸单位为 mm

8.2 Taping Specifications 编带规格 10φ and 14φ:

Taping Code 编带代码 AU: AMMO, P 25.4mm/P0 12.7mm/lead space 7.5mm

Taping Code 编带代码 AV: REEL, P 25.4mm/P0 12.7mm/lead space 7.5mm

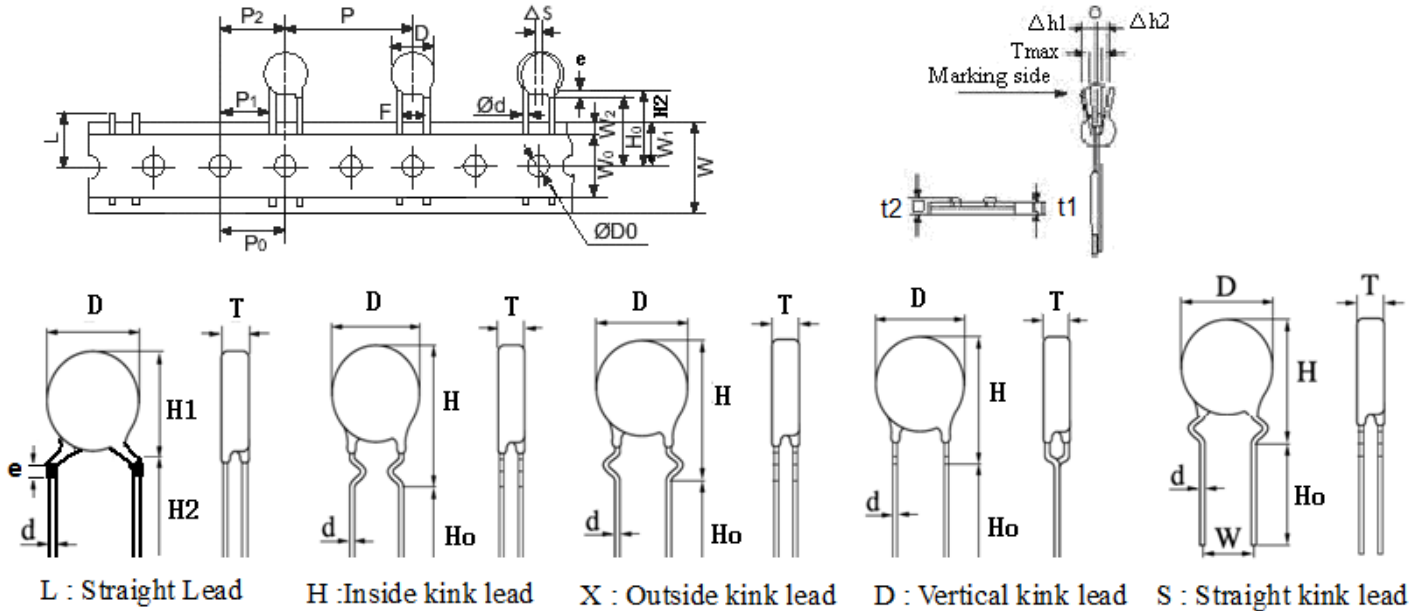

Item 项目	Taping code 编带代码: AU & AV						
	10φ			14φ			
Lead Type Code 线脚代码	L	X, H, S	D	L	X, H, S	D	
Body Diameter 本体直径	D	14.0 Max	14.0 Max	14.0 Max	17.5Max	17.5Max	17.5Max
Lead Wire Diameter 线脚直径	d	0.8±0.05	0.8±0.05	0.8±0.05	0.8±0.05	0.8±0.05	0.8±0.05
Pitch of Component 零件间距	P	25.4±1	25.4±1	25.4±1	25.4±1	25.4±1	25.4±1
Hole Center to Component Center 孔中心与零件中心距离	P2	12.7±0.3	12.7±0.3	12.7±0.3	12.7±0.3	12.7±0.3	12.7±0.3
Feed Hole Pitch 纸带孔中心距	P0	12.7±0.3	12.7±0.3	12.7±0.3	12.7±0.3	12.7±0.3	12.7±0.3
Lead to Lead Distance (Center to Center) 线脚中心距离	F	7.5±0.5	7.5±0.5	7.5±0.5	7.5±0.5	7.5±0.5	7.5±0.5
Component Alignment 零件前后偏移	Δh	2.0Max	2.0Max	2.0Max	2.0Max	2.0Max	2.0Max
Deviation along tape, life or right 本体偏移	ΔS	0±2.0	0±2.0	0±2.0	0±2.0	0±2.0	0±2.0
Base paper Tape Width 纸带宽度	W	18 +1.0/-0.5	18 +1.0/-0.5	18 +1.0/-0.5	18 +1.0/-0.5	18 +1.0/-0.5	18 +1.0/-0.5
Adhesive Tape Width 胶带宽度	W0	8.0Min	8.0Min	8.0Min	8.0Min	8.0Min	8.0Min
Hole Position 孔定位	W1	9±0.5	9±0.5	9±0.5	9±0.5	9±0.5	9±0.5
Adhesive Tape Border 胶带边缘距	W2	1.5Max	1.5Max	1.5Max	1.5Max	1.5Max	1.5Max
Coating extension on leads 线脚上包封脚长	e	1.0Max	—	—	1.0Max	—	—
Feed Hole Diameter 定位孔孔径	D0	4±0.2	4±0.2	4±0.2	4±0.2	4±0.2	4±0.2
Total Tape Thickness 纸带总厚度	t2	<1.8	<1.8	<1.8	<1.8	<1.8	<1.8
Length of Clipped Lead 裁切后线脚长度	L	11Max	11Max	11Max	11Max	11Max	11Max
Lead-Wire Clinch Height 线脚高度	Ho	—	16±1.0	16±1.0	—	16±1.0	16±1.0
Lead distance between the bottom of body and the center of sprocket hole 线脚高度(本体底至孔中心)	H2	18±2	—	—	18±2	—	—
Component Height from Seating Plane 零件插板后高度	H	—	20Max	20Max	—	23.5Max	23.5Max
	H1	17.0Max	—	—	20.5Max	—	—

All dimensions are in millimeters. 尺寸单位为 mm

8.3 Taping Specifications 编带规格 20φ:

Taping Code 编带代码 AW: AMMO, P 25.4mm/P0 12.7mm/lead space 10.0mm

Taping Code 编带代码 AX: REEL, P 25.4mm/P0 12.7mm/lead space 10.0mm

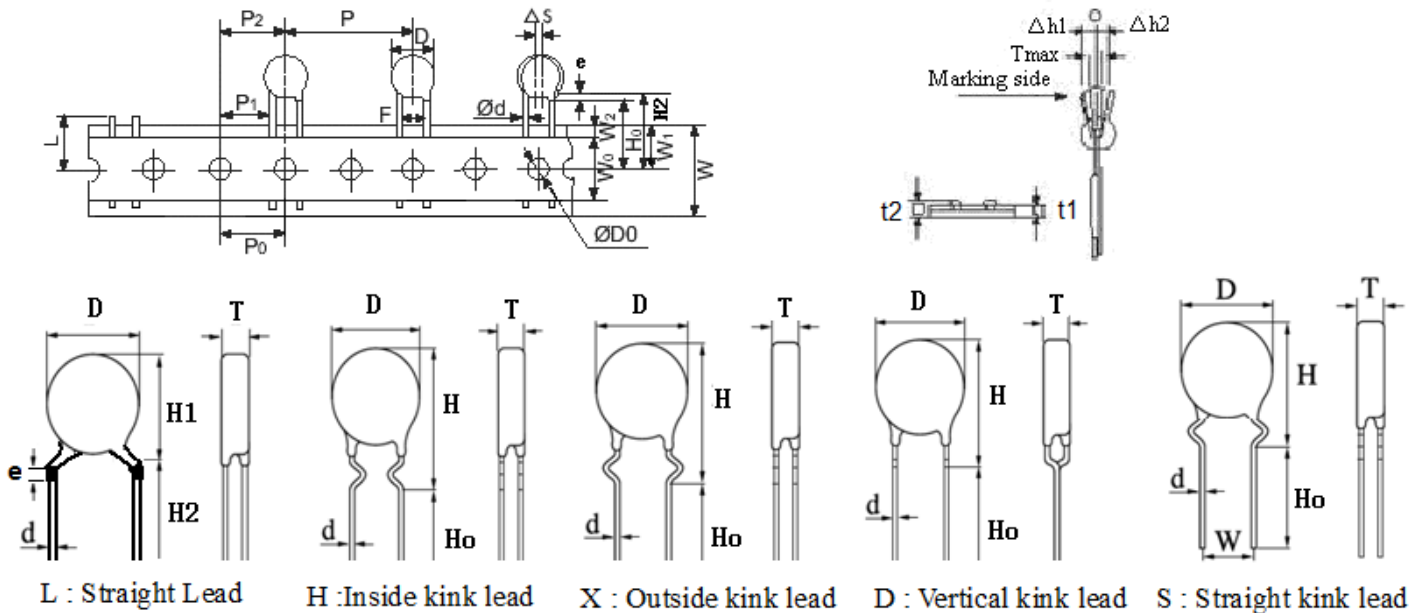

Item 项目 Item 项目		Taping code 编带代码: AW & AX		
		Disk Size: 20Φ		
Lead Type Code 线脚代码		L	X, H, S	D
Body Diameter 本体直径	D	24Max	24Max	24Max
Lead Wire Diameter 线脚直径	d	1.0±0.1	1.0±0.1	1.0±0.1
Pitch of Component 零件间距	P	25.4±1	25.4±1	25.4±1
Hole Center to Component Center 孔中心与零件中心距离	P2	12.7±0.3	12.7±0.3	12.7±0.3
Feed Hole Pitch 纸带孔中心距	P0	12.7±0.3	12.7±0.3	12.7±0.3
Lead to Lead Distance (Center to Center) 线脚中心距离	F	10.0±0.5	10.0±0.5	10.0±0.5
Component Alignment 零件前后偏移	Δh	2.0Max	2.0Max	2.0Max
Deviation along tape, life or right 本体偏移	ΔS	0±2.0	0±2.0	0±2.0
Base paper Tape Width 纸带宽度	W	18 +1.0/-0.5	18 +1.0/-0.5	18 +1.0/-0.5
Adhesive Tape Width 胶带宽度	W0	8.0Min	8.0Min	8.0Min
Hole Position 孔定位	W1	9±0.5	9±0.5	9±0.5
Adhesive Tape Border 胶带边缘距	W2	1.5Max	1.5Max	1.5Max
Coating extension on leads 线脚上包封脚长	e	1.5Max	--	--
Feed Hole Diameter 定位孔孔径	D0	4±0.2	4±0.2	4±0.2
Total Tape Thickness 纸带总厚度	t2	<2.0	<2.0	<2.0
Length of Clipped Lead 裁切后线脚长度	L	11Max	11Max	11Max
Lead-Wire Clinch Height 线脚高度	Ho	—	16±1.0	16±1.0
Lead distance between the bottom of body and the center of sprocket hole 线脚高度(本体底至孔中心)	H2	18±2	—	—
Component Height from Seating Plane 零件插板后高度	H	—	31.5Max	31.5Max
	H1	28.5Max	—	—

All dimensions are in millimeters. 尺寸单位为 mm

8.4 Taping Specifications 编带规格 7φ:

Taping Code 编带代码 AF: AMMO, P 15.0mm/P0 15.0mm/lead space 5.0mm

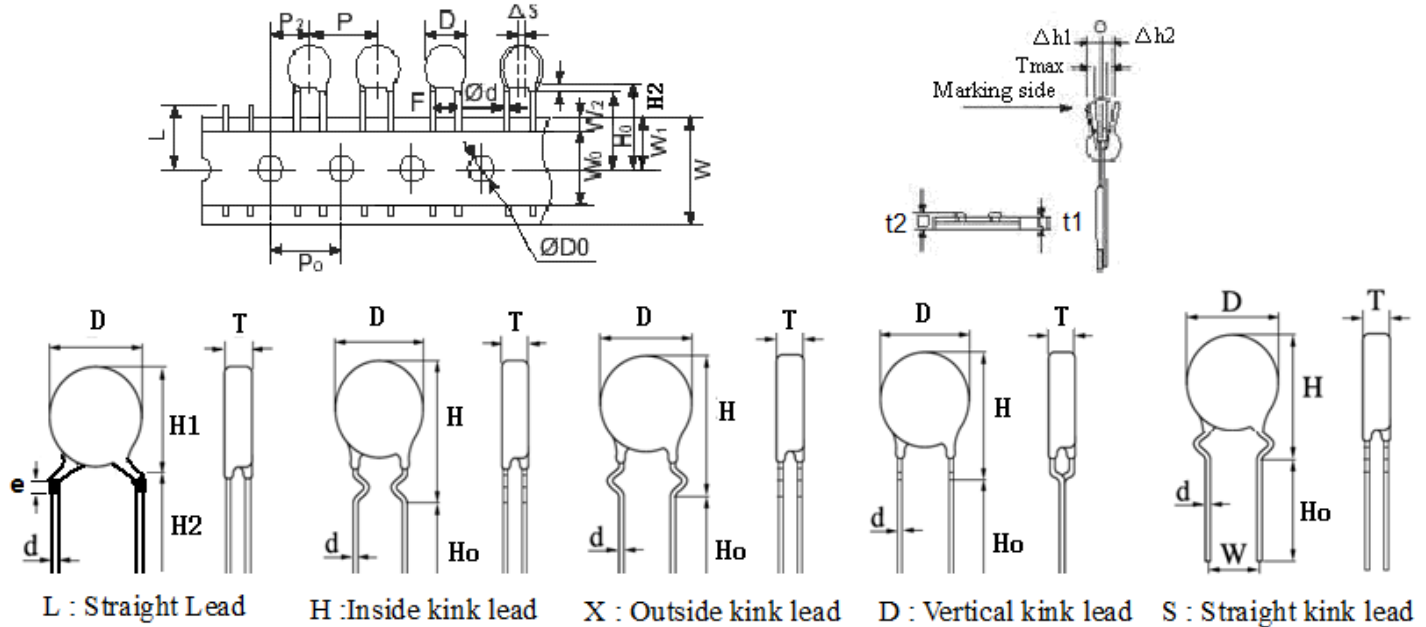

Item 项目		Taping code 编带代码: AF		
		Disk Size: 7φ		
Lead Type Code 线脚代码		L	X, H, S	D
Body Diameter 本体直径	D	10.0 Max	10.0 Max	10.0 Max
Lead Wire Diameter 线脚直径	d	0.55±0.05	0.55±0.05	0.55±0.05
Pitch of Component 零件间距	P	15.0±1	15.0±1	15.0±1
Feed Hole Pitch 纸带孔中心距	P0	15.0±1	15.0±1	15.0±1
Hole Center to Component Center 孔中心与零件中心距离	P2	7.5±0.7	7.5±0.7	7.5±0.7
Lead to Lead Distance (Center to Center) 线脚中心距离	F	5.0±0.5	5.0±0.5	5.0±0.5
Component Alignment 零件前后偏移	Δh	2.0Max	2.0Max	2.0Max
Deviation along tape, life or right 本体偏移	ΔS	0±2.0	0±2.0	0±2.0
Base paper Tape Width 纸带宽度	W	18 +1.0/-0.5	18 +1.0/-0.5	18 +1.0/-0.5
Adhesive Tape Width 胶带宽度	W0	8.0Min	8.0Min	8.0Min
Hole Position 孔定位	W1	9±0.5	9±0.5	9±0.5
Adhesive Tape Border 胶带边缘距	W2	1.5Max	1.5Max	1.5Max
Lead-Wire Clinch Height 线脚高度	H0	—	16±0.5	16±0.5
Lead distance between the bottom of body and the center of sprocket hole 线脚高度(本体底至孔中心)	H2	18±2	—	—
Feed Hole Diameter 定位孔孔径	D0	4±0.2	4±0.2	4±0.2
Total Tape Thickness 纸带总厚度	t2	<1.5	<1.5	<1.5
Length of Clipped Lead 裁切后线脚长度	L	11Max	11Max	11Max
Coating extension on leads 线脚上包封脚长	e	1.0Max	—	—
Component Height from Seating Plane 零件插板后高度	H	—	15.5Max	15.5Max
	H1	13.5Max	—	—

All dimensions are in millimeters. 尺寸单位为 mm

8.5 Taping Specifications 编带规格 10φ and 14φ:

Taping Code 编带代码 AF: AMMO, P 15.0mm/P0 15.0mm/lead space 7.5mm

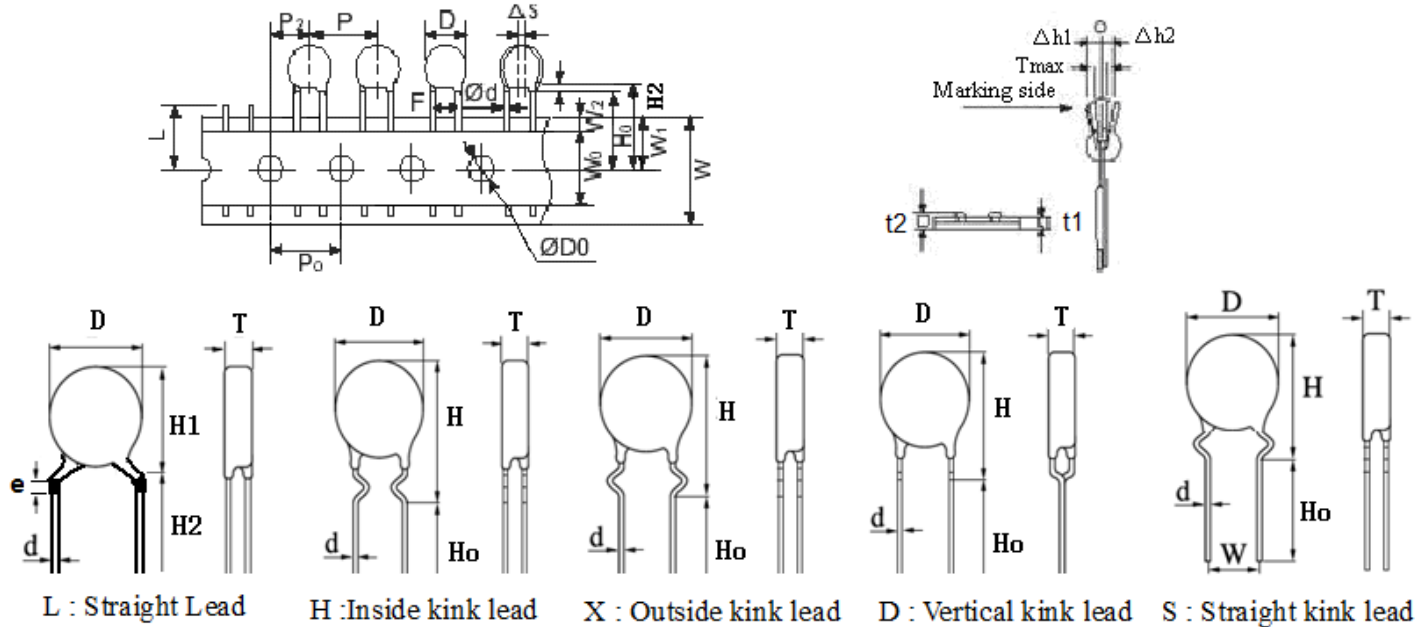

Item 项目	Taping code 编带代码: AF						
	10φ			14φ			
Lead Type Code 线脚代码	L	X, H, S	D	L	X, H, S	D	
Body Diameter 本体直径	D	14.0 Max	14.0 Max	14.0 Max	17.5Max	17.5Max	17.5Max
Lead Wire Diameter 线脚直径	d	0.8±0.05	0.8±0.05	0.8±0.05	0.8±0.05	0.8±0.05	0.8±0.05
Pitch of Component 零件间距	P	15.0±1	15.0±1	15.0±1	15.0±1	15.0±1	15.0±1
Hole Center to Component Center 孔中心与零件中心距离	P2	7.5±0.5	7.5±0.5	7.5±0.5	7.5±0.5	7.5±0.5	7.5±0.5
Feed Hole Pitch 纸带孔中心距	P0	15.0±1	15.0±1	15.0±1	15.0±1	15.0±1	15.0±1
Lead to Lead Distance (Center to Center) 线脚中心距离	F	7.5±0.5	7.5±0.5	7.5±0.5	7.5±0.5	7.5±0.5	7.5±0.5
Component Alignment 零件前后偏移	Δh	2.0Max	2.0Max	2.0Max	2.0Max	2.0Max	2.0Max
Deviation along tape, life or right 本体偏移	ΔS	0±2.0	0±2.0	0±2.0	0±2.0	0±2.0	0±2.0
Base paper Tape Width 纸带宽度	W	18 +1.0/-0.5	18 +1.0/-0.5	18 +1.0/-0.5	18 +1.0/-0.5	18 +1.0/-0.5	18 +1.0/-0.5
Adhesive Tape Width 胶带宽度	W0	8.0Min	8.0Min	8.0Min	8.0Min	8.0Min	8.0Min
Hole Position 孔定位	W1	9±0.5	9±0.5	9±0.5	9±0.5	9±0.5	9±0.5
Adhesive Tape Border 胶带边缘距	W2	1.5Max	1.5Max	1.5Max	1.5Max	1.5Max	1.5Max
Coating extension on leads 线脚上包封脚长	e	1.0Max	—	—	1.0Max	—	—
Feed Hole Diameter 定位孔孔径	D0	4±0.2	4±0.2	4±0.2	4±0.2	4±0.2	4±0.2
Total Tape Thickness 纸带总厚度	t2	<1.8	<1.8	<1.8	<1.8	<1.8	<1.8
Length of Clipped Lead 裁切后线脚长度	L	11Max	11Max	11Max	11Max	11Max	11Max
Lead-Wire Clinch Height 线脚高度	Ho	—	16±1.0	16±1.0	—	16±1.0	16±1.0
Lead distance between the bottom of body and the center of sprocket hole 线脚高度(本体底至孔中心)	H2	18±2	—	—	18±2	—	—
Component Height from Seating Plane 零件插板后高度	H	—	20Max	20Max	—	23.5Max	23.5Max
	H1	17.0Max	—	—	20.5Max	—	—

All dimensions are in millimeters. 尺寸单位为 mm

8.6 Taping Specifications 编带规格 14φ and 20φ:



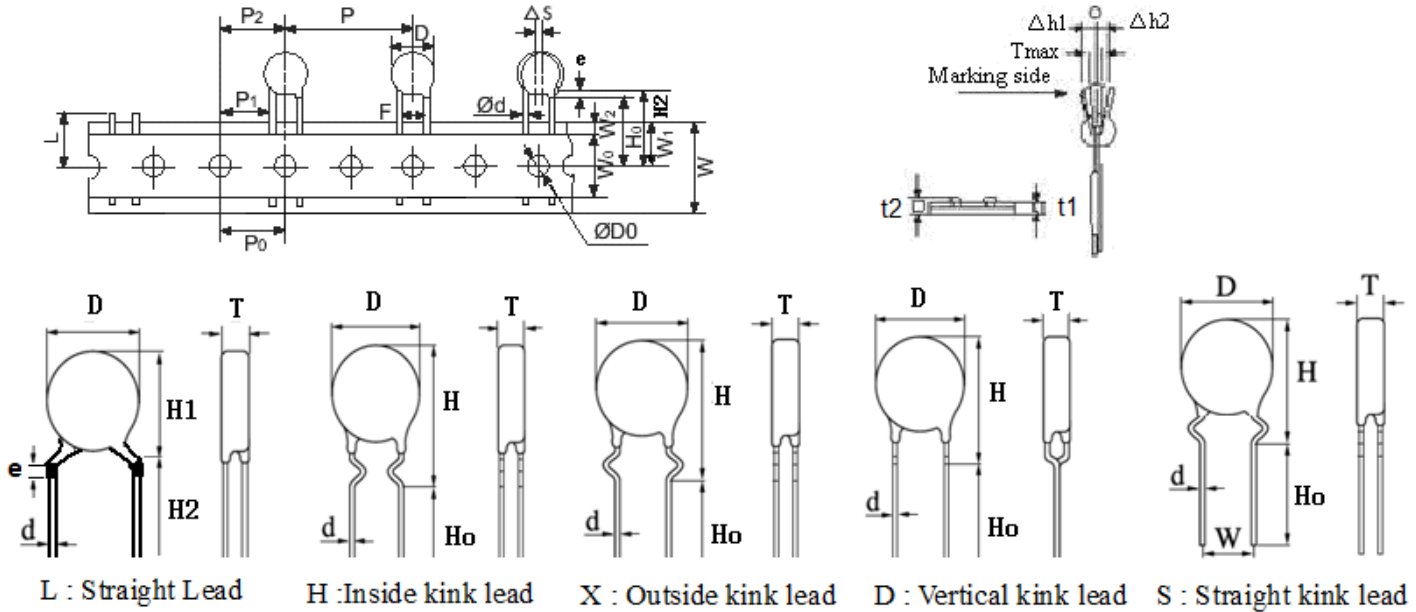

Taping Code 编带代码 AT: AMMO, P 30.0mm/P0 15.0mm/lead space 7.5mm or 10mm



Item 项目		Taping code 编带代码: AT					
		Disk Size: 14Φ			Disk Size: 20Φ		
Lead Type Code 线脚代码		L	X, H, S	D	L	X, H, S	D
Body Diameter 本体直径	D	17.5Max	17.5Max	17.5Max	24Max	24Max	24Max
Lead Wire Diameter 线脚直径	d	0.8±0.05	0.8±0.05	0.8±0.05	1.0±0.1	1.0±0.1	1.0±0.1
Pitch of Component 零件间距	P	30.0±1	30.0±1	30.0±1	30.0±1	30.0±1	30.0±1
Hole Center to Component Center 孔中心与零件中心距离	P2	15.0±1	15.0±1	15.0±1	15.0±1	15.0±1	15.0±1
Feed Hole Pitch 纸带孔中心距	P0	15.0±1	15.0±1	15.0±1	15.0±1	15.0±1	15.0±1
Lead to Lead Distance (Center to Center) 线脚中心距离	F	7.5±0.5	7.5±0.5	7.5±0.5	10.0±0.5	10.0±0.5	10.0±0.5
Component Alignment 零件前后偏移	Δh	2.0Max	2.0Max	2.0Max	2.0Max	2.0Max	2.0Max
Deviation along tape, life or right 本体偏移	ΔS	0±2.0	0±2.0	0±2.0	0±2.0	0±2.0	0±2.0
Base paper Tape Width 纸带宽度	W	18 +1.0/-0.5	18 +1.0/-0.5	18 +1.0/-0.5	18 +1.0/-0.5	18 +1.0/-0.5	18 +1.0/-0.5
Adhesive Tape Width 胶带宽度	W0	8.0Min	8.0Min	8.0Min	8.0Min	8.0Min	8.0Min
Hole Position 孔定位	W1	9±0.5	9±0.5	9±0.5	9±0.5	9±0.5	9±0.5
Adhesive Tape Border 胶带边缘距	W2	1.5Max	1.5Max	1.5Max	1.5Max	1.5Max	1.5Max
Coating extension on leads 线脚上包封脚长	e	1.0Max	—	—	1.5Max	—	—
Feed Hole Diameter 定位孔孔径	D0	4±0.2	4±0.2	4±0.2	4±0.2	4±0.2	4±0.2
Total Tape Thickness 纸带总厚度	t2	<2.0	<2.0	<2.0	<2.0	<2.0	<2.0
Length of Clipped Lead 裁切后线脚长度	L	11Max	11Max	11Max	11Max	11Max	11Max
Lead-Wire Clinch Height 线脚高度	Ho	—	16±1.0	16±1.0	—	16±1.0	16±1.0
Lead distance between the bottom of body and the center of sprocket hole 线脚高度(本体底至孔中心)	H2	18±2	—	—	18±2	—	—
Component Height from Seating Plane 零件插板后高度	H	—	31.5Max	31.5Max	—	31.5Max	31.5Max
	H1	28.5Max	—	—	28.5Max	—	—

All dimensions are in millimeters. 尺寸单位为 mm

9. Marking 印字:

9.1. Company trade mark 商标			
9.2. Type 型号	V		
9.3. Varistor voltage 压敏电压	3-digit-system		
9.4. Tolerance of varistor voltage 压敏电压允差	K:±10%		
9.5. Energy type 能量类别	D=Standard energy type 标准能量品; E=High energ 高能量品;		
9.6. Products ID 产品识别号	Abbreviationex.: A 5 1234 → Last 4 digits of Lot No. ↓ → Month of manufacture: Last digits of year: 1: January A: 2015 : B: 2016 9: September C: 2017 O: October : N: November X: 2038 D: December Y: 2039 Z: 2040		
9.7. Approved monogram 认证图示:			
(1) CQC		(3) UL	
(2) VDE		(4) cUL	

Marking sample 印字图例(Only marked VDE/CQC/UL on the body 产品本体仅印 VDE/CQC/UL 标示)

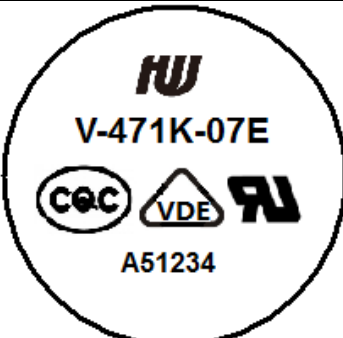
D series	E series
	

10. Specification and test method 规格及测试方法:

10.1 Electrical 电气性能:

Test condition 测试条件: Temperature range 温度 : 5 to 35°C, Relative humidity 相对湿度: 45 to 85% R.H.

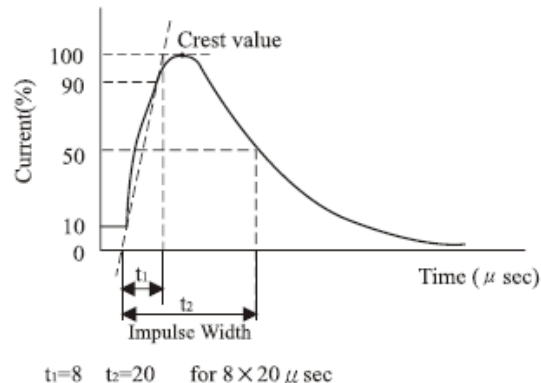
No	Items 项目	Performance 性能要求	Testing method 测试方法			
10.1.1	Varistor Voltage	To meet the specified value	Voltage across the varistor measured at 1 mA DC rectangular pulse current.			
10.1.2	Maximum Allowable Voltage		Maximum continuous sinusoidal rms voltage or DC voltage which may be applied within the specified environmental temperature range			
10.1.3	Maximum Clamping Voltage		Peak voltage across the varistor under condition of a specified standard impulse current (8/20 μ s) 			
10.1.4	Withstanding Surge Current		Maximum current across the varistor measured at a given standard waveform (8/20 μ s) applied one time or two times with the varistor voltage less than $\pm 10\%$			
10.1.5	Maximum Energy		The maximum energy within the varistor voltage change of $\pm 10\%$ when one impulse of 2ms or 10/1000 μ s is applied			
10.1.6	Rated Transient Average Power Dissipation		Maximum average power which may be dissipated due to a group of pulses occurring within a specified isolated time period, without causing device failure			
10.1.7	Capacitance (Reference)		Capacitance between the terminals of the varistor measured at 1 kHz, 1 Vrms, zero bias and room temperature (Exception 100pF below measured at 1MHz)			
10.1.8	Temperature Coefficient of Varistor Voltage		Should be less than -0.05%/°C $(V \text{ at } 85^{\circ}\text{C} - V \text{ at } 25^{\circ}\text{C}) / (V \text{ at } 25^{\circ}\text{C} \times 60) \times 100(\%/^{\circ}\text{C})$			
10.1.9	Withstanding Voltage (Body insulation)		No breakdown The specified voltage shall be applied both terminals of the varistor connected together and metal foil closely wrapped round its body for 3~6mm : <table border="1" data-bbox="853 1691 1412 1792"> <thead> <tr> <th>Classification (Varistor Voltage)</th> <th>Test Voltage (AC)</th> </tr> </thead> <tbody> <tr> <td>V_{1mA}</td> <td>2500 Vrms</td> </tr> </tbody> </table>	Classification (Varistor Voltage)	Test Voltage (AC)	V _{1mA}
Classification (Varistor Voltage)	Test Voltage (AC)					
V _{1mA}	2500 Vrms					

10.2 Mechanical 机械性能:

No	Items 项目	Performance 性能要求	Testing method 测试方法								
10.2.1	Terminal Pull Strength	Lead wire shall not cut off. Varistor shall not be broken.	JIS-C-0051 The two terminals shall be no outstanding damage visually after gradually applying the force listed below: <table border="1" data-bbox="826 510 1436 656"> <thead> <tr> <th>Terminal Diameter</th> <th>Force</th> </tr> </thead> <tbody> <tr> <td>0.55mm</td> <td>9.8 N (1.0kgf)</td> </tr> <tr> <td>0.8mm</td> <td>9.8 N (1.0kgf)</td> </tr> <tr> <td>1.0mm</td> <td>19.6 N (2.0kgf)</td> </tr> </tbody> </table>	Terminal Diameter	Force	0.55mm	9.8 N (1.0kgf)	0.8mm	9.8 N (1.0kgf)	1.0mm	19.6 N (2.0kgf)
Terminal Diameter	Force										
0.55mm	9.8 N (1.0kgf)										
0.8mm	9.8 N (1.0kgf)										
1.0mm	19.6 N (2.0kgf)										
10.2.2	Terminal Bending Strength		JIS-C-0051 Hold the specimen and keep its lead-out axis vertical Suspend 1 Kg weight on the terminal. Bend the specimen through 90° then return to the original position. Repeat the procedure in the opposite direction. Test and examine every terminal.								
10.2.3	Vibration	Varistors shall be no visible defect	JIS-C-0040 Varistors subjected to simple harmonic motion of 0.75mm amplitude between limits of 10-55 HZ. Frequency scan shall be traversed in 1 min. This motion shall then be applied for period of 2 Hrs in each of three mutually perpendicular directions.								
10.2.4	Solderability	The two terminals shall be covered uniformly with solder approximately 95%	JIS-C-5102 Dipping the terminals to a depth of approximately 3 mm from the body in a soldering bath of 260±5°C for 2±0.5 sec.								
10.2.5	Resistance to Soldering Heat	Varistors shall be no outstanding damage and the variation varistor voltage should be less than ±5% ($\Delta V_B / V_B = \pm 5\%$).	JIS-C-5102 The terminals shall be dipped into a solder bath having a temperature 300±5°C to a point 2.0 to 2.5 mm from the body of the unit, using the shielding board (thickness 1.5 mm), be held there for 10±1sec, and then be stored at room condition* for 1 to 2 Hrs.								

※1. "Room condition" Temperature: 15~35, Relative humidity: 45~75%, Atmospheric pressure: 860~1060kPa

10.3 Environment and endurance 耐候性能:

No	Items 项目	Performance 性能要求	Testing method 测试方法															
10.3.1	Dry Heat (High Temperature)	The variation of varistor voltage should be less than $\pm 5\%$ ($\Delta V_B/V_B = \pm 5\%$).	JIS-C-5023 Varistors shall be subjected to $125 \pm 2^\circ\text{C}$, for 1000 hrs in a thermostatic bath without load and then stored at room condition* for 1 to 2 hrs.															
10.3.2	Damp Heat (Humidity)	The variation of varistor voltage should be less than $\pm 5\%$ ($\Delta V_B/V_B = \pm 5\%$).	JIS-C-5023 Varistors shall be subjected to $40 \pm 2^\circ\text{C}$, 90 to 95%R.H. for 1000 Hrs in a thermostatic bath without load and then stored at room condition* for 1 to 2 Hrs.															
10.3.4	Cold (Low Temperature Storage)	The variation of varistor voltage should be less than $\pm 5\%$ ($\Delta V_B/V_B = \pm 5\%$).	JIS-C-5021 Varistors shall be subjected to $-40 \pm 2^\circ\text{C}$ for 1000 Hrs in a thermostatic bath without load and then stored at room condition* for 1 to 2 Hrs.															
10.3.5	Temperature Cycle (Thermal shock)	The variation of varistor voltage should be less than $\pm 5\%$ and no outstanding damage visually.	JIS-C-5030 The temperature cycling listed below shall be repeated 5 times. <table border="1" data-bbox="868 1240 1401 1411"> <thead> <tr> <th>Step</th> <th>Temperature($^\circ\text{C}$)</th> <th>Time(minutes)</th> </tr> </thead> <tbody> <tr> <td>1</td> <td>-40 ± 2</td> <td>30 ± 2</td> </tr> <tr> <td>2</td> <td>Room Temp.</td> <td>3 max.</td> </tr> <tr> <td>3</td> <td>125 ± 2</td> <td>30 ± 2</td> </tr> <tr> <td>4</td> <td>Room Temp.</td> <td>3 max.</td> </tr> </tbody> </table>	Step	Temperature($^\circ\text{C}$)	Time(minutes)	1	-40 ± 2	30 ± 2	2	Room Temp.	3 max.	3	125 ± 2	30 ± 2	4	Room Temp.	3 max.
Step	Temperature($^\circ\text{C}$)	Time(minutes)																
1	-40 ± 2	30 ± 2																
2	Room Temp.	3 max.																
3	125 ± 2	30 ± 2																
4	Room Temp.	3 max.																
10.3.6	Dry Heat Load (High Temperature)	The variation of varistor voltage should be less than $\pm 10\%$ ($\Delta V_B/V_B = \pm 10\%$)	JIS-C-5036 Varistors shall be subjected to $85 \pm 2^\circ\text{C}$ for 1000 Hrs in a thermostatic bath with maximum allowable voltage continuously applied and then stored at room condition* for 1 to 2 Hrs.															

※1. "Room condition" Temperature: $15 \sim 35$, Relative humidity: $45 \sim 75\%$, Atmospheric pressure: $860 \sim 1060\text{kPa}$

11. Packing Specification 包装规格:

11.1 Bulk packing 散料包装:

11.1.1 Quantity 数量:

Disk size 产品尺寸	Varistor Voltage 压敏电压	pcs/Bag(包)	pcs/Box(盒)	pcs/Carton (箱)
07	820K-471K	1000	3000	24000
	561K-911K	1000	2000	16000
10	820K-621K	500	1500	12000
	681K-911K	500	1000	8000
	Above 951K	250	1000	8000
14	820K-911K	250	1000	8000
	Above 951K	100	500	4000
20	820K-621K	250	500	4000
	Above 681K	100	300	2400

11.1.2 Size of packing 包装尺寸:

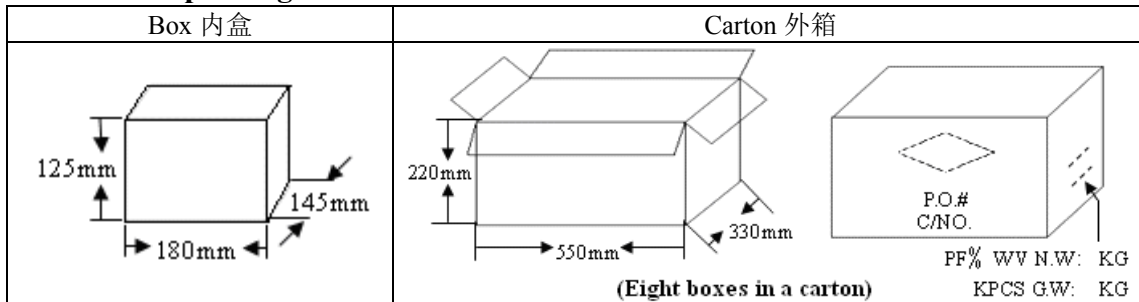

11.2 Taping packing 编带包装:

11.2.1 Quantity 数量:

Disk size 产品尺寸	Varistor Voltage 压敏电压	Ammo box 折叠盒装	
		pcs / Box pcs/盒	pcs / Carton pcs/箱
07	≅ 431K	1500	15000
	≅ 471K	1000	10000
10 / 14 / 20	≅ 431K	500	5000
10 / 14 / 20	≅ 471K	300	3000

Note: Ammo box and reel quantities may vary. 注: 折叠盒装和卷盘装数量可能会改变.

11.2.2 Size of packing 包装尺寸:

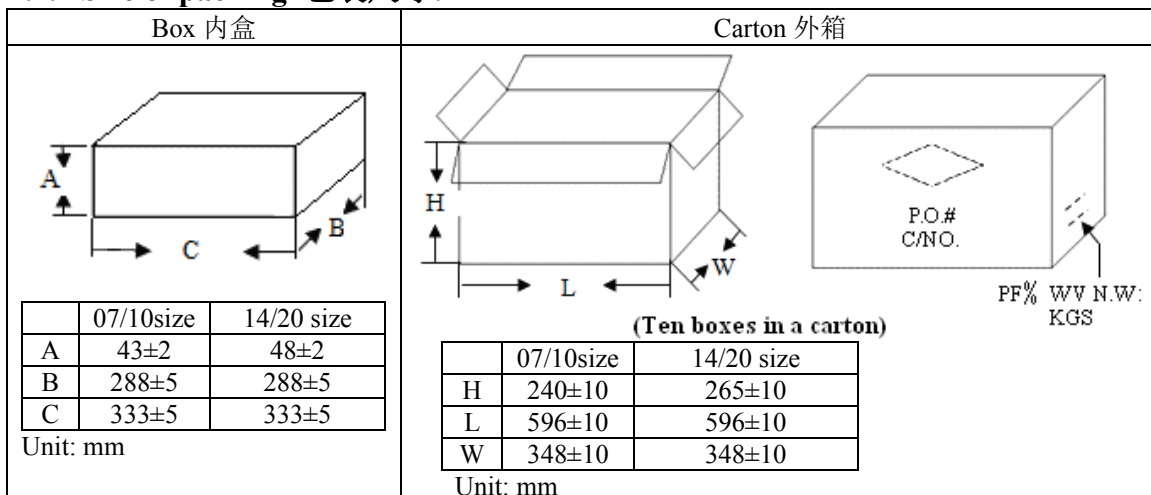

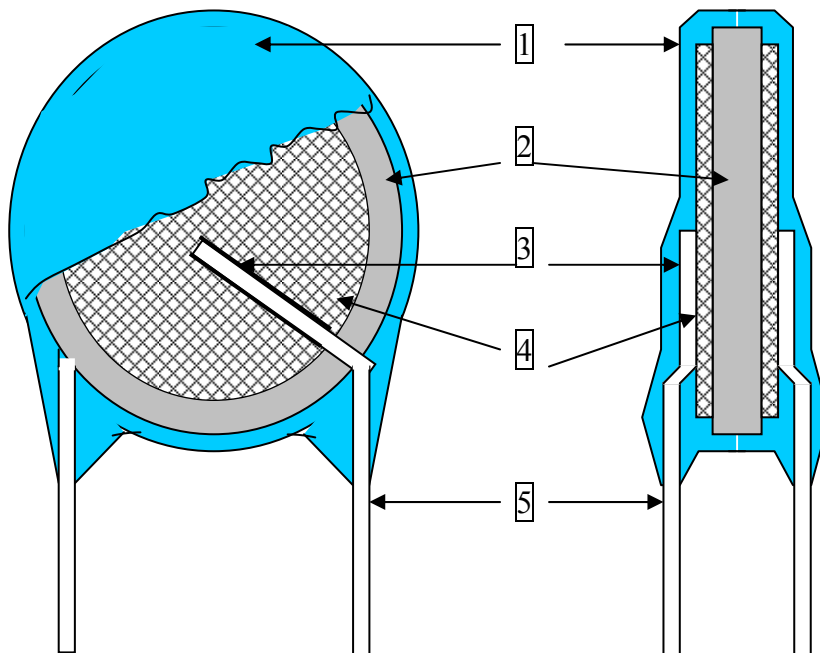
12. Drawing of internal structure and material list 结构图 and 材料列表:

Remarks 摘要:

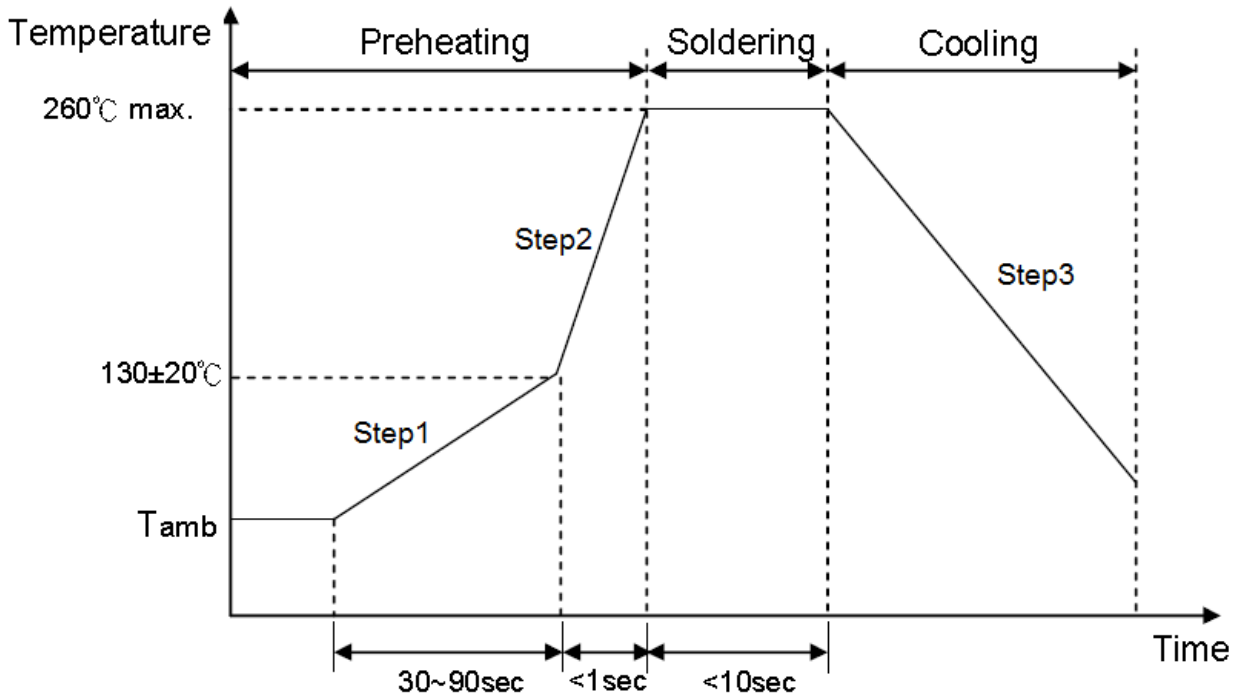
No.	Part name 名称	Material 材料	Component 组成
1	Insulation Coating 绝缘涂层	Epoxy polymer 环氧聚合物	Epoxy resin、Pigment (Blue / UL 94 V-0 /) 环氧树脂、颜料
2,4	Dielectric Element 电介质层	Ceramic 陶瓷片	ZnO
3	Solder 焊料	Tin-alloy 锡合金	Sn/Ag; Sn/Ag/Cu
5	Leads wire 引线	Tinned copper clad steel wire 镀锡铜包钢线	Substrate metal: Fe & Cu Surface plating: Sn 底料: Fe & Cu 镀层: Sn

13. Soldering recommendation 焊接条件建议:
13.1 Wave soldering profile 波峰焊:

Step1: $(1\sim3)^\circ\text{C/sec}$
 Step2: Approx. 200°C/sec
 Step3: 5°C/sec Max

13.2 Recommended reworking conditions with soldering iron 重工烙铁焊:

Item	Conditions
Temperature of Soldering Iron-tip	350°C (max.)
Soldering Time	3 sec (max.)
Distance from Varistor	2 mm (min.)